



A new typology of storage units that represents a 3D innovation making a visual and functional use of the side section as well as the front one. Usually, the storage unit side view is never considered in terms of utilization, but for juxtaposition. The system consists either of column units, base units, stackable or hanging units.

Featuring large-sized compartments, divided in a functional way to receive and organise everyday objects, books, magazines or electronic equipment.

The system's flexibility is considerable: swivel modules, with drawers or large drawers, with flap opening door, stackable modular units or modular units to be flanked, free-standing or wall-mounted.

The elements can be highly customised: the open compartments as well as the rotary units may feature different materials and/or colours and can be newly varied by the customer even after their purchase.

## Typologies

All units are made of medium-density wood fibreboard (1.6 cm thick), varnished in matt white, 48 cm deep. They are divided into two main categories:

- **column storage units** with doors, 185.5 cm high, with a 2.5 cm plinth and adjustable small feet available in the following lengths: 34, 45, 53 cm. Only the L34 and L53 cm modules are equipped with an open rotary storage unit, made of medium-density wood fibreboard, 8 mm thick. Column storage units with rotary units are reversible vertically. The column with a single door features three internal shelves, one fixed and two adjustable (+/- 3 cm.) L53 columns with rotary unit and single door have been developed with five internal shelves, four fixed and one adjustable (+/- 3 cm) L34 columns with rotary unit and single door have been developed with four internal shelves, three fixed and one adjustable (+/- 3 cm)
- **low ground-resting storage units** (base unit), 32 cm high with a 2.5 cm

plinth and adjustable small feet; available in the following lengths 53, 85, 144, 203 cm.

- **low stackable storage units**, 32 cm high with a 1.6 cm spacer;
- **low hanging storage units**, 32 cm high, in length 53, 85, 144 cm; equipped with a kit for wall mounting. The low ground-resting and stackable storage units can be used in the middle of the room as well.

Low units are provided in the following configurations:

- C** - drawer with a one-piece front
- R** - downward flap opening with single door
- G/C\*** - 8 mm thick open compartment (G), and internal drawers (C)
- G/R\*** - 8mm thick open compartment (G), and (R) downward flap opening with single door
- C/C** - two-front large drawer and internal drawers (only in lengths: 53, 85, 144cm)
- R/R** - downward flap opening door and upward flap drawer (in length 85cm only).

## \*Electrified units

The **G/C** and **G/R** units\* in length 144 and 203cm (base, stackable and hanging units) are also available in the version arranged for cable management, with a white-lacquered

aluminium door (L8 D7 cm) on the top of the storage unit.

## Finishes

Units are always varnished in matt white; only open compartments and rotary compartments are available in the following options:

- matt white, green, orange, blue, sand, ivory, yellow and anthracite grey
- natural wood\* and natural grey wood\*
- frosted glass

\*Multilaminar wood composed of veneers based on precious woods such as ayous, poplar and lime.

The special manufacturing process allows to highlight the typical features of wood-types through creative aesthetic and customised figures. Environmentally-friendly and fully made of woods coming from forests and plantations managed following sustainability standards.

## Recommendations for composition

- column units with swivel storage unit must be flanked keeping a distance of 5 cm from one another to allow the open unit to rotate fully. Columns include an alignment kit. Moreover, such a distance is also an aesthetic feature of the project.
- on demand, a depth adjustment device can be ordered to be used between the columns (see page 16).
- feet allow for the adjustment of the column/low unit directly from inside the base
- we recommend to stack maximum four units (total height 135.3 cm)
- in the event of unit installation into niches, please contact our Sales Office to double-check dimensions.

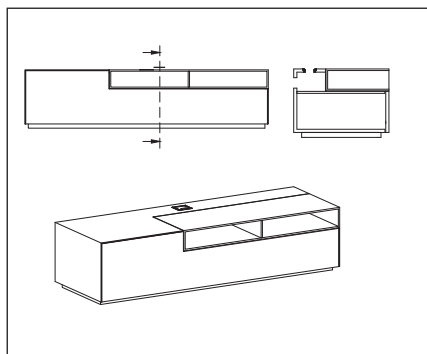

# INMOTION

units for composition

## COLUMN STORAGE UNITS (D 48 cm, H 185.5 + plinth 2.5 cm)

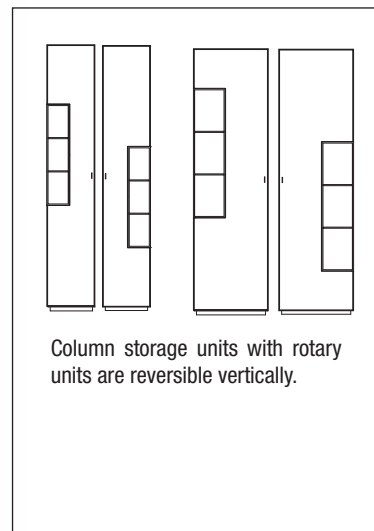
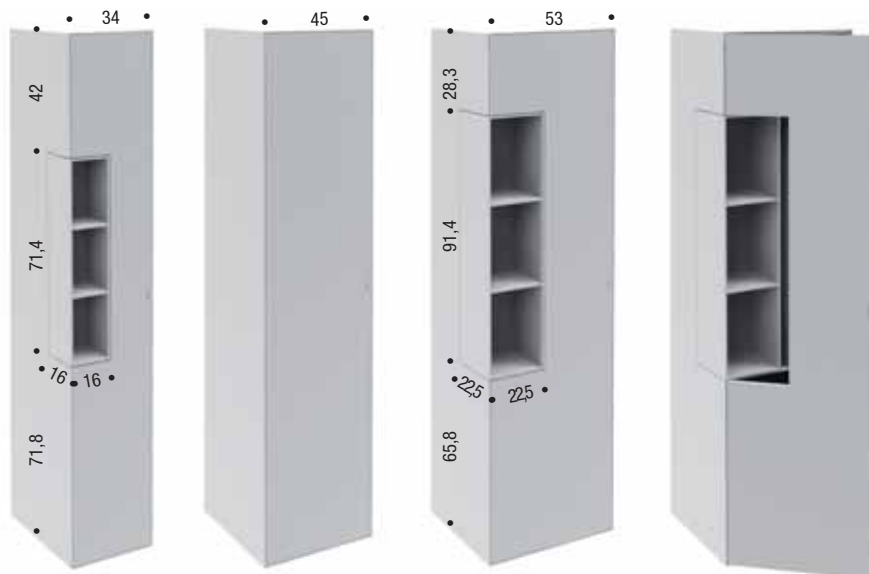

with rotary unit and single door with 4 internal shelves (3 fixed and 1 adjustable)

with a single door and 3 internal shelves (1 fixed and 2 adjustable)

with rotary unit and single door with 5 internal shelves (4 fixed and 1 adjustable)

## SHIM ELEMENT

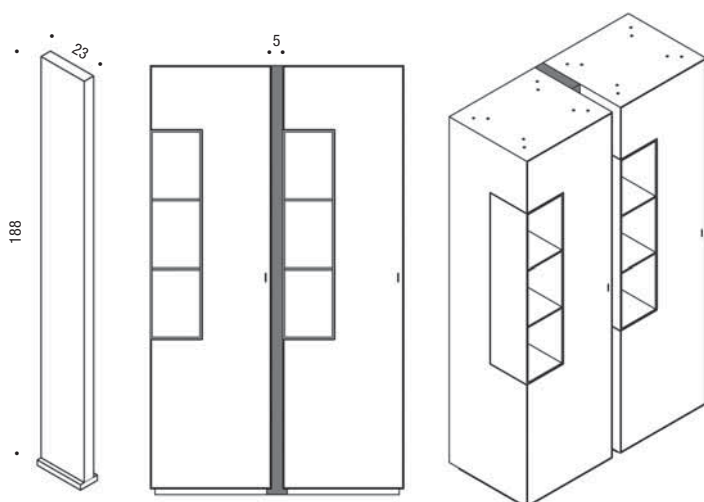

## ROTARY UNIT AND OPEN UNIT: matt varnishes

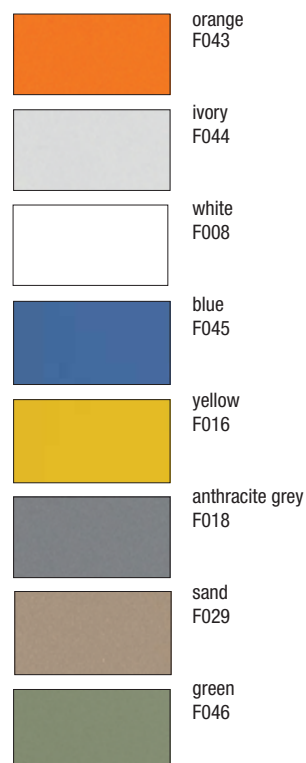

# INMOTION

units for composition

■ GROUND-RESTING STORAGE UNITS (D 48 cm, H 32 + PLINTH 2.5 cm)

■ STACKABLE STORAGE UNITS (D 48 cm, H 32 + SPACER 1.6 cm)

LENGTH 53 CM

LENGTH 85 CM

LENGTH 144 CM

LENGTH 203 CM

drawer with a one-piece front (C)



downward flap opening with single door (R)



open compartment and drawer (G/C) - (L144 and L203 also in electrified version)



open compartment and downward flap (G/R) - (L144 and L203 also in electrified version)



with drawer, large drawer, small drawer (C/C)

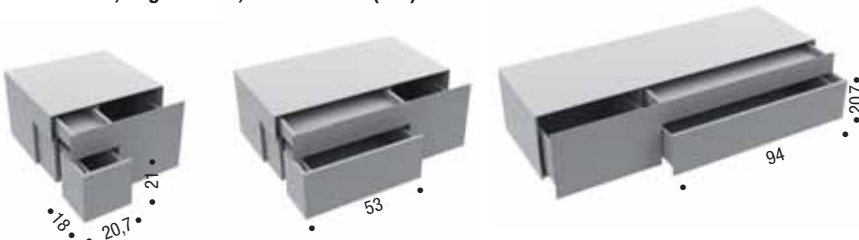

downward flap and upward flap drawer (R/R)

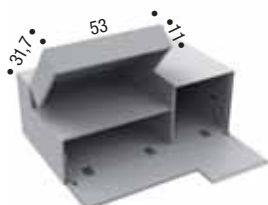



**HANGING STORAGE UNITS (D 48 cm, H 32)**

**LENGTH 53 CM**

**LENGTH 85 CM**

**LENGTH 144 CM**

**drawer with a one-piece front (C)**



**with downward flap opening with single door (R)**



**open compartment and drawer (G/C) - (L 144 also in electrified version)**



**open compartment and downward flap (G/R) - (L 144 also in electrified version)**



**with drawer, large drawer, small drawer (C/C)**

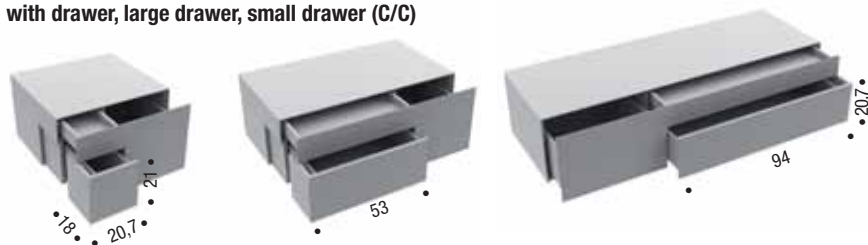

**downward flap and upward flap drawer (R/R)**

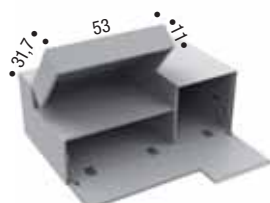

# INMOTION

examples of compositions

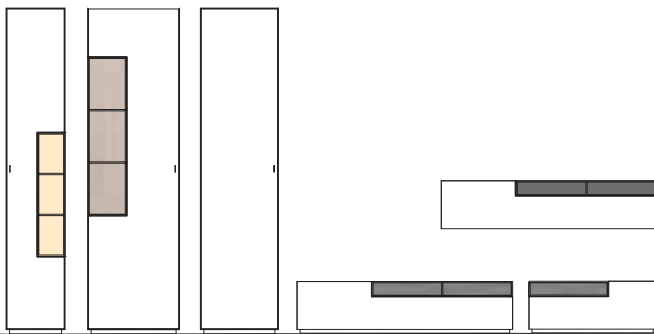

- A**
- 1 column unit L34 with door and rotary unit in ivory colour
  - 1 column unit L53 with door and rotary unit in natural wood
  - 1 column unit L45 with door
  - 1 base unit L144 open comp. in nat.grey wood and large drawer
  - 1 base unit L85 open comp. in nat.grey wood and large drawer
  - 1 hanging unit L144 open comp. in green colour and downward flap

F012227 F044  
 F012225 F048  
 F012226-0001  
 F012207 W144 F 049  
 F012207 W085 F049  
 F012215 W144 F046

**TOTAL**

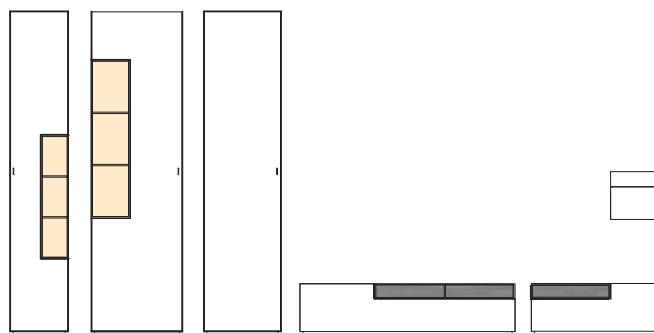

- B**
- 1 column unit L34 with door and rotary unit in ivory colour
  - 1 column unit L53 with door and rotary unit in ivory colour
  - 1 column unit L45 with door
  - 1 base unit L144 open comp. in nat.grey wood and large drawer
  - 1 base unit L85 open comp. in nat.grey wood and large drawer
  - 1 hanging unit L85 with downward flap and upward flap opening drawer
  - 1 hanging unit L144 with drawer and large drawer
  - 1 hanging unit L53 with drawer and large drawer

F012227 F044  
 F012225 F044  
 F012226-0001  
 F012207 W144 F049  
 F012207 W085 F049  
 F012224 W085  
 F012221 W144  
 F012221 W053

**TOTAL**



- C**
- 1 hanging unit L85 with downward flap and upward flap opening drawer
  - 1 hanging unit L144 with drawer and large drawer
  - 1 hanging unit L53 with drawer and large drawer

F012224 W085  
 F012221 W144  
 F012221 W053

**TOTAL**

# INMOTION

examples of compositions

www.deprojectinrichter.com  
088 - 650 12 34

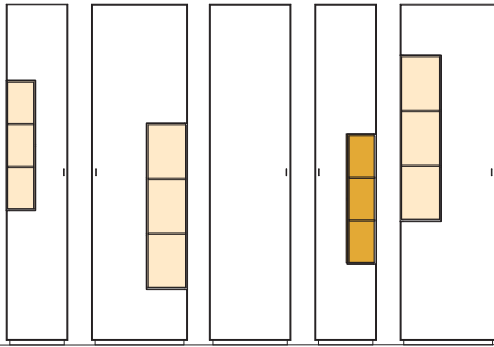

- D** 1 column unit L34 with door and rotary unit in ivory colour  
2 column units L53 with door and rotary unit in ivory colour  
1 column unit L45 with door  
1 column unit L34 with door and rotary unit in yellow colour

F012227 F044  
F012225 F044  
F012226-0001  
F012227 F016

**TOTAL**



- E** 1 base unit L203 with large drawer  
1 stackable unit L203 open comp. in grey colour and downward flap  
1 base unit L144 with drawer and large drawer  
1 base unit L53 with drawer and large drawer

F012201 W203  
F012214 W144  
F012219 W144  
F012219 W053

**TOTAL**

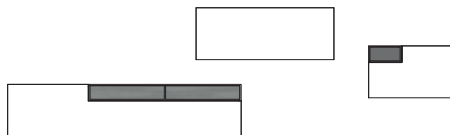

- F** 1 hanging unit L144 open comp. in nat. grey wood and downward flap  
1 hanging unit L85 with downward flap  
1 hanging unit L53 open comp. in green colour and downward flap

F012215 W144 F049  
F012206 W085  
F012215 W053 F046

**TOTAL**

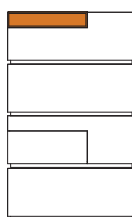

- G** 1 base unit L85 with large drawer  
1 stackable unit L85 with drawer and large drawer  
1 stackable unit L85 with downward flap  
1 stackable unit L85 open comp. in orange colour and downward flap

F012201 W085  
F012220 W085  
F012202 W085  
F012214 W085 F043

**TOTAL**