

PRODUCT FACT SHEET

FIBER CHAIR - SLED BASE FURNITURE / LIGHTING / ACCESSORIES

Iskos-Berlin on the design "One of the most difficult and noble disciplines is to design without eccentricity. To create simple, well-functioning, almost ordinary objects that nevertheless have strong identities. We designed FIBER CHAIR to do just that with a clear sculptural language that refuses to compromise on comfort. It's a chair stripped of all unnecessary layers leaving the chair with a seat, back and armrests that is integrated in one harmonious shell, perfect for nesting yourself into. The iconic form marries soft, embracing curves with an environmentally friendly wood fiber composite, giving FIBER CHAIR a distinctive tactile texture while also keeping it 100% recyclable."

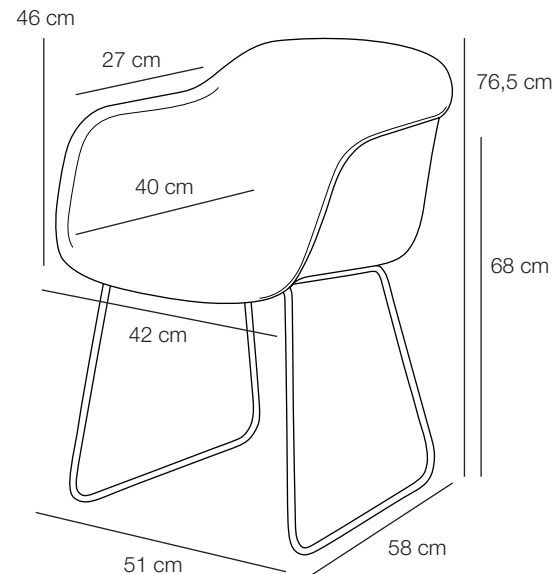













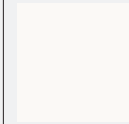
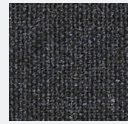
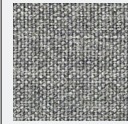
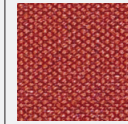

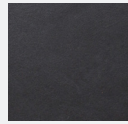



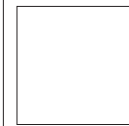















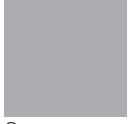

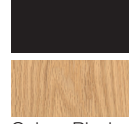
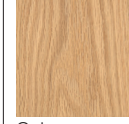

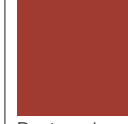
PROCESS	The wood and plastic composition is heated and poured into a mold that presses the chair's shell. The steel sled base is CNC-bent and powder coated.
DESIGNED BY / YEAR OF DESIGN	Iskos-Berlin / 2014
TYPE	Chair
DESCRIPTION	Fiber chair is an all-round easily understandable chair, made of a new innovative shell material of recyclable plastic and wood fibers. With an eye for detail, every line and every curve has been relentlessly altered to balance maximum comfort with minimum space. With a vast palate of shell colors, premium upholstery and leather options, and four different bases, there is a FIBER CHAIR for any dining room, desk, conference hall, auditorium, or office. As the chair is made from natural materials, small variations in color and structure can occur.
ENVIRONMENT	Indoor
DIMENSIONS (CM)	Total height: 76,5 cm / Total width: 51 cm / Total depth: 58 cm Armrest height: 68 cm / Armrest depth: 27 cm Seat height: 46 cm / Seat depth: 40 cm / Seat width: 42 cm
MATERIAL	Shell consists of a wood and plastic composition with 25% wood fibers, 70% PP (polypropylene) and 5% coloured PP. Sled base is made from powder coated steel.
COLOURS	Grey/grey, dusty green/dusty green, nature/black, natural white/white
STANDARD TEXTILE UPHOLSTERY	Textile from Kvadrat. Remix 183/black, Remix 133/grey, Remix 643/dusty red
STANDARD LEATHER UPHOLSTERY	Leather from Camo leathers. Cognac Silk leather/black, Black Silk leather/black
CLEANING INSTRUCTIONS	Clean with a moist cloth. If necessary use a little dish soap on the cloth. For upholstery versions please find cleaning instructions for your chosen textile at www.kvadrat.com or for leather at www.camo.com
TEST AND CERTIFICATIONS	Danish Technological Institute - EN 15373 L2. Tested to withstand level 2: Extreme use. Tested to withstand use in areas where the furniture is occasionally or repeatedly subject to extremely high loads. i.e. nightclubs, railway stations, transport terminals.
ABOUT THE DESIGNER	Iskos-Berlin is a Copenhagen-based design duo that has made international headlines within furniture, industrial and graphic design. The studio, formerly known as Komplot Design has collaborated with some of the World's most prestigious manufacturers and their furniture, lighting and other design products are exhibited at numerous design museums around the world including MoMA and the Danish Design Museum.

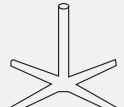

PRODUCT FACT SHEET

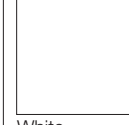
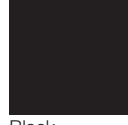
FIBER CHAIR FURNITURE / LIGHTING / ACCESSORIES

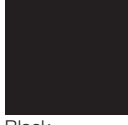
STANDARD COLOURS & TEXTILES

	SHELL COLOUR				KVADRAT UPHOLSTERY			LEATHER	
 PLASTIC SHELL	 Grey	 Dusty green	 Nature	 Natural white	 Kvadrat Remix 183	 Kvadrat Remix 133	 Kvadrat Remix 643	 Leather Silk Cognac	 Leather Silk Black
 TUBE BASE	 Grey	 Dusty green	 Black	 White	 Black	 Grey	 Dusty red	 Black	 Black
 SLED BASE	 Grey	 Dusty green	 Black	 White	 Black	 Grey	 Dusty red	 Black	 Black
 WOOD BASE	 Grey	 Dusty green	 Oak or Black	 Oak	 Black	 Grey	 Dusty red	 Oak	 Black
 SWIVEL BASE	 Grey	 Dusty green	 Black	 White	 Black	 Grey	 Dusty red	 Black	 Black

PRODUCT FACT SHEET

FIBER CHAIR - SWIVEL BASE FURNITURE / LIGHTING / ACCESSORIES

Iskos-Berlin on the design "One of the most difficult and noble disciplines is to design without eccentricity. To create simple, well-functioning, almost ordinary objects that nevertheless have strong identities. We designed FIBER CHAIR to do just that with a clear sculptural language that refuses to compromise on comfort. It's a chair stripped of all unnecessary layers leaving the chair with a seat, back and armrests that is integrated in one harmonious shell, perfect for nesting yourself into. The iconic form marries soft, embracing curves with an environmentally friendly wood fiber composite, giving FIBER CHAIR a distinctive tactile texture while also keeping it 100% recyclable."

PROCESS

The wood and plastic composition is heated and poured into a mold that presses the chair's shell. The 4 leg swivel piece is die casted aluminium, casted in one piece. Cylinder is aluminium. The swivel base has a return spindle.

DESIGNED BY / YEAR OF DESIGN TYPE

Iskos-Berlin / 2014
Chair

DESCRIPTION

Fiber chair is an all-round easily understandable chair, made of a new innovative shell material of recyclable plastic and wood fibers. With an eye for detail, every line and every curve has been relentlessly altered to balance maximum comfort with minimum space. With a vast palate of shell colors, premium upholstery and leather options, and four different bases, there is a FIBER CHAIR for any dining room, desk, conference hall, auditorium, or office. As the chair is made from natural materials, small variations in color and structure can occur.

ENVIRONMENT

Indoor

DIMENSIONS (CM)

Total height: 76,5 cm / Total width: 51 cm / Total depth: 58 cm
Armrest height: 68 cm / Armrest depth: 27 cm
Seat height: 46 cm / Seat depth: 40 cm / Seat width: 42 cm

MATERIAL

Shell consists of a wood and plastic composition with 25% wood fibers, 70% PP (polypropylene) and 5% coloured PP.

COLOURS

Grey/grey, dusty green/dusty green, nature/black, natural white/white

STANDARD TEXTILE UPHOLSTERY

Upholstery textile from Kvadrat. Remix 183/black, Remix 133/grey, Remix 643/dusty red

STANDARD LEATHER UPHOLSTERY

Upholstery leather from Camo leathers. Cognac Silk leather/black, Black Silk leather/black

CLEANING INSTRUCTIONS

Clean with a moist cloth. If necessary use a little dish soap on the cloth. For upholstery versions please find cleaning instructions for your chosen textile at www.kvadrat.com or for leather at www.ca-mo.com

ABOUT THE DESIGNER

Iskos-Berlin is a Copenhagen-based design duo that has made international headlines within furniture, industrial and graphic design. The studio, formerly known as Komplot Design has collaborated with some of the World's most prestigious manufacturers and their furniture, lighting and other design products are exhibited at numerous design museums around the world including MoMA and the Danish Design Museum.

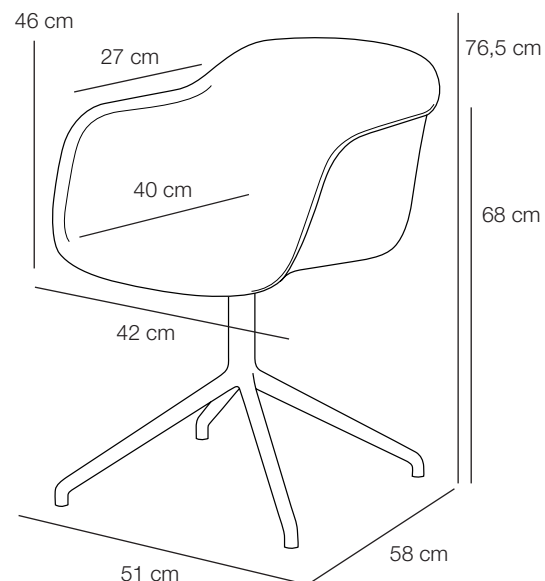

PRODUCT FACT SHEET

FIBER CHAIR - TUBE BASE FURNITURE / LIGHTING / ACCESSORIES

Iskos-Berlin on the design "One of the most difficult and noble disciplines is to design without eccentricity. To create simple, well-functioning, almost ordinary objects that nevertheless have strong identities. We designed FIBER CHAIR to do just that with a clear sculptural language that refuses to compromise on comfort. It's a chair stripped of all unnecessary layers leaving the chair with a seat, back and armrests that is integrated in one harmonious shell, perfect for nesting yourself into. The iconic form marries soft, embracing curves with an environmentally friendly wood fiber composite, giving FIBER CHAIR a distinctive tactile texture while also keeping it 100% recyclable."

PROCESS	The wood and plastic composition is heated and poured into a mold that presses the chair's shell. The steel tube base is CNC-bent and powder coated.
DESIGNED BY / YEAR OF DESIGN	Iskos-Berlin / 2014
TYPE	Chair
DESCRIPTION	Fiber chair is an all-round easily understandable chair, made of a new innovative shell material of recyclable plastic and wood fibers. With an eye for detail, every line and every curve has been relentlessly altered to balance maximum comfort with minimum space. With a vast palate of shell colors, premium upholstery and leather options, and four different bases, there is a FIBER CHAIR for any dining room, desk, conference hall, auditorium, or office. As the chair is made from natural materials, small variations in color and structure can occur.
ENVIRONMENT	Indoor
DIMENSIONS (CM)	Total height: 76,5 cm / Total width: 51 cm / Total depth: 58 cm Armrest height: 68 cm / Armrest depth: 27 cm Seat height: 46 cm / Seat depth: 40 cm / Seat width: 42 cm
MATERIAL	Shell consists of a wood and plastic composition with 25% wood fibers, 70% PP (polypropylene) and 5% coloured PP. Tube base is made from powder coated steel.
COLOURS	Grey/grey, dusty green/dusty green, nature/black, natural white/white
STANDARD TEXTILE UPHOLSTERY	Textile from Kvadrat. Remix 183/black, Remix 133/grey, Remix 643/dusty red
STANDARD LEATHER UPHOLSTERY	Leather from Camo leathers. Cognac Silk leather/black, Black Silk leather/black
CLEANING INSTRUCTIONS	Clean with a moist cloth. If necessary use a little dish soap on the cloth. For upholstery versions please find cleaning instructions for your chosen textile at www.kvadrat.com or for leather at www.ca-mo.com
TEST AND CERTIFICATIONS	Danish Technological Institute - EN 15373 L2. Tested to withstand level 2: Extreme use. Tested to withstand use in areas where the furniture is occasionally or repeatedly subject to extremely high loads. i.e. night-clubs, railway stations, transport terminals.
ABOUT THE DESIGNER	Iskos-Berlin is a Copenhagen-based design duo that has made international headlines within furniture, industrial and graphic design. The studio, formerly known as Komplot Design has collaborated with some of the World's most prestigious manufacturers and their furniture, lighting and other design products are exhibited at numerous design museums around the world including MoMA and the Danish Design Museum.

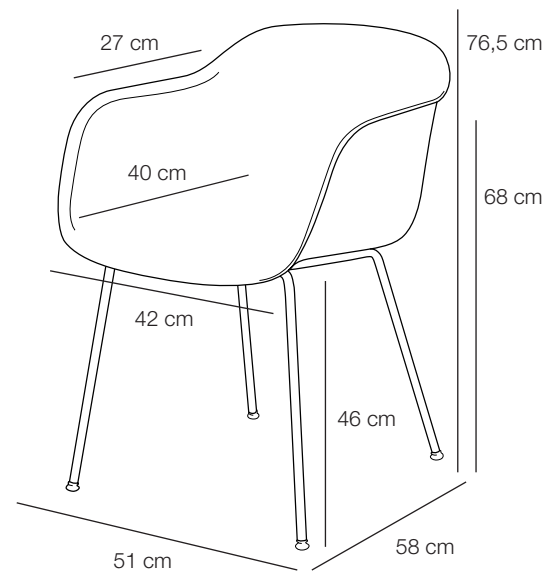

PRODUCT FACT SHEET

FIBER CHAIR - WOOD BASE FURNITURE / LIGHTING / ACCESSORIES

Iskos-Berlin on the design "One of the most difficult and noble disciplines is to design without eccentricity. To create simple, well-functioning, almost ordinary objects that nevertheless have strong identities. We designed FIBER CHAIR to do just that with a clear sculptural language that refuses to compromise on comfort. It's a chair stripped of all unnecessary layers leaving the chair with a seat, back and armrests that is integrated in one harmonious shell, perfect for nesting yourself into. The iconic form marries soft, embracing curves with an environmentally friendly wood fiber composite, giving FIBER CHAIR a distinctive tactile texture while also keeping it 100% recyclable."

PROCESS	The wood and plastic composition is heated and poured into a mold that presses the chair's shell. The wood base is cut from solid oak wood, polished and powder lacquered for the coloured chairs.
DESIGNED BY / YEAR OF DESIGN	Iskos-Berlin / 2014
TYPE	Chair
DESCRIPTION	Fiber chair is an all-round easily understandable chair, made of a new innovative shell material of recyclable plastic and wood fibers. With an eye for detail, every line and every curve has been relentlessly altered to balance maximum comfort with minimum space. With a vast palate of shell colors, premium upholstery and leather options, and four different bases, there is a FIBER CHAIR for any dining room, desk, conference hall, auditorium, or office. As the chair is made from natural materials, small variations in color and structure can occur.
ENVIRONMENT	Indoor
DIMENSIONS (CM)	Total height: 76,5 cm / Total width: 51 cm / Total depth: 58 cm Armrest height: 68 cm / Armrest depth: 27 cm Seat height: 46 cm / Seat depth: 40 cm / Seat width: 42 cm
MATERIAL	Shell consists of a wood and plastic composition with 25% wood fibers, 70% PP (polypropelen) and 5% coloured PP. Wood base is made from solid PU lacquered, oak wood.
COLOURS	Grey/grey, dusty green/dusty green, nature/oak, nature/black, natural white/oak
STANDARD TEXTILE UPHOLSTERY	Textile from Kvadrat. Remix 183/black, Remix 133/grey, Remix 643/dusty red
STANDARD LEATHER UPHOLSTERY	Leather from Camo leathers. Cognac Silk leather/black, Black Silk leather/black
CLEANING INSTRUCTIONS	Clean with a moist cloth. If necessary use a little dish soap on the cloth. For upholstery versions please find cleaning instructions for your chosen textile at www.kvadrat.com or for leather at www.ca-mo.com
TEST AND CERTIFICATIONS	Danish Technological Institute - EN 15373 L2. Tested to withstand level 2: Extreme use. Tested to withstand use in areas where the furniture is occasionally or repeatedly subject to extremely high loads. i.e. nightclubs, railway stations, transport terminals.
ABOUT THE DESIGNER	Iskos-Berlin is a Copenhagen-based design duo that has made international headlines within furniture, industrial and graphic design. The studio, formerly known as Komplot Design has collaborated with some of the World's most prestigious manufacturers and their furniture, lighting and other design products are exhibited at numerous design museums around the world including MoMA and the Danish Design Museum.

