

gargantua

technical sheet

The content of this document, in particular the mentioned models, is protected by copyrights and/or design rights. The present document and its content is communicated to you for information purposes only. Any partial or total reproduction or any other use without our prior written permission is strictly prohibited. This technical sheet remains subject to possible changes. All dimensions are in mm, unless mentioned otherwise. Extremis is not responsible for the errors in the documentation of products. All measurements are approximate and are provided for informational purposes only.

Version 20130621

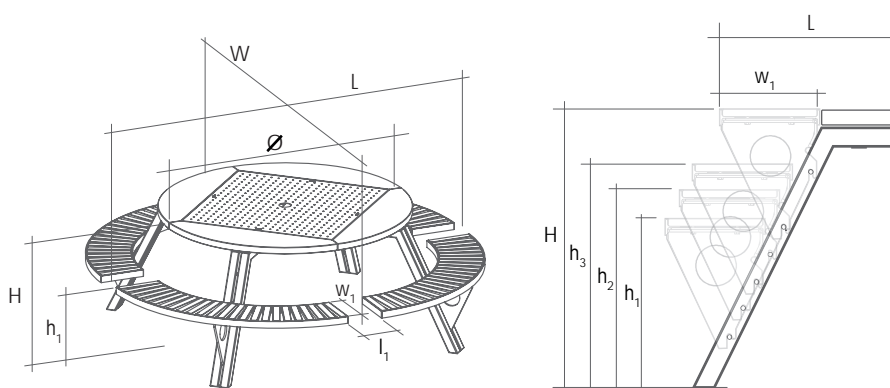

product dimensions (mm)	∅	L	W	H	l ₁	w ₁	h ₁
position 1 (adults)	1460	2309	2309	751	209	270	450
position 2 (small child)	1460	2235	2235	751	157	270	524
position 3 (medium child)	1460	2161	2161	751	105	270	599
position 4 (big table)	1460	2014	2014	751	1	270	751

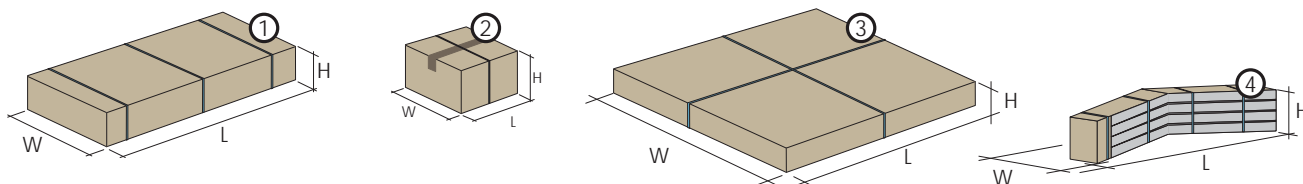

box dimensions (mm)	L	W	H	qty (#)	volume (m ³)	gross weight (kg)	net weight (kg)	packaging weight (kg)
box 1 (2 benches)	1437	515	100	2	0,14	66,96	63,44	3,52
box 2 (connection)	460	460	240	1	0,05	16,27	15,71	0,56
box 3 (tabletop)	1540	1540	100	1	0,24	59,00	53,04	5,96
box 4 (4 legs)	315	265	235	1	0,05	34,96	34,40	0,56
<i>total</i>					<i>0,48</i>	<i>177,19</i>	<i>166,59</i>	<i>10,60</i>

OPTIONAL BACKRESTS

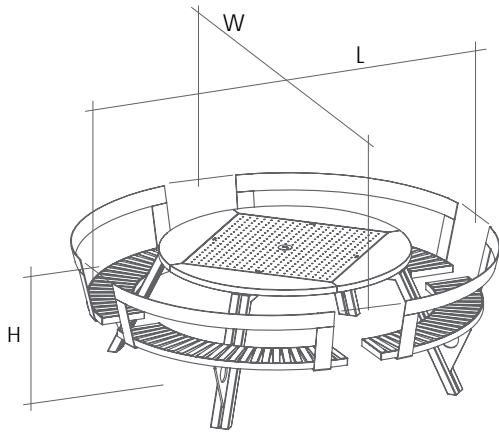

product dimensions (mm)	L	W	H
position 1 (adults)	2480	2480	787
position 2 (small child)	2406	2406	861
position 3 (medium child)	2332	2332	942
position 4 (big table)	-	-	-

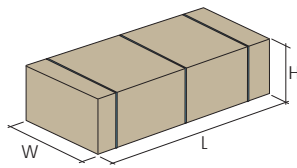

box dimensions (mm)	L	W	H	qty (#)	volume (m ³)	gross weight (kg)	net weight (kg)	packaging weight (kg)
backrests (2 pieces)	1415	465	440	1	0,29	25,52	21,02	4,50
backrests (4 pieces)	1415	465	440	2	0,579	46,54	42,04	4,50

OPTIONAL CUSHIONS

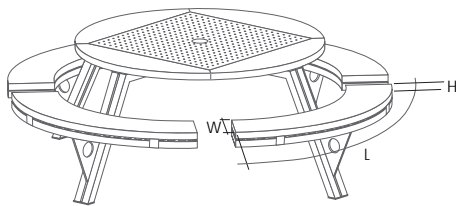

product dimensions (mm)	L	W	H
cushion	1550	280	45

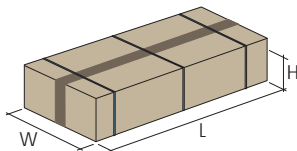

box dimensions (mm)	L	W	H	qty (#)	volume (m ³)	gross weight (kg)	net weight (kg)	packaging weight (kg)
cushions (4 pieces)	1415	465	190	1	0,13	5,55	2,54	3,01





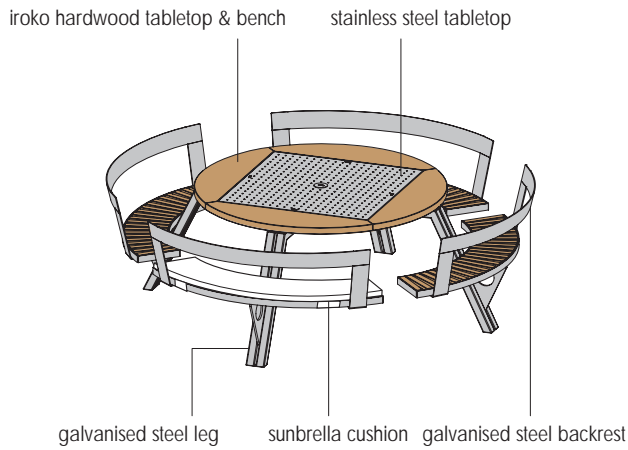

MATERIALS

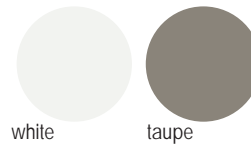

cushion colour options:

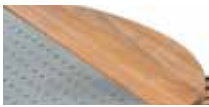

materials	key facts	thickness	layer thickness	density	in/out-door	water	UV colour fastness	flame retarding
		mm	micron	10 ³ kg/m ³				
Galvanised steel legs, benches and backrests 	<ul style="list-style-type: none"> - most durable method for protecting metal from rusting - protective layer - very long life span - can perfectly be recycled 	2 - 10	50 - 100	7,5	outdoor & indoor	n.a.	very good: galvanisation will however become dull when used outdoors	NEN-EN13501-1 A1*
Stainless steel tabletop 	<ul style="list-style-type: none"> - high rusting resistance - periodical maintenance 	2	n.a.	8,0	outdoor & indoor	n.a.	very good	NEN-EN13501-1 A1*
Iroko tabletop & benches 	<ul style="list-style-type: none"> - few maintenance - FSC label 	20 - 40	n.a.	0,6 - 0,7	outdoor & indoor	n.a.	untreated wood turns grey after a while	/
Sunbrella cushion 	<ul style="list-style-type: none"> - 100% acrylic - best outdoor fabric available for making cushions 	0.5	n.a.	0,27	outdoor & indoor	the fabric has a water column of 35 mbar (EN 20811)	7/8 (ISO 105-B02)	/

* NEN-EN13501-1 A1: Class A1 products will not contribute in any stage of the fire including the fully developed fire. For that reason they are assumed to be capable of satisfying automatically all requirements of all lower classes.



APPLICATIONS

Private: on terraces, patios
Public: hotel and catering industry,
company terraces, public squares, ...

Needed space: 4 m²

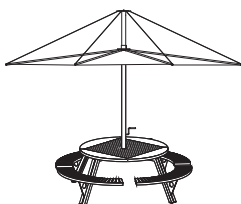

INSTRUCTIONS

Every leg of the table has four support brackets, one for every height of the bench. To change the height of a bench, grab the bench with both hands on the frame (see picture) and subsequently hook it in at the desired height between the two tubes of the legs.

1. Unhook
2. Position 1: for adults
3. Position 2: for tall children and small adults
4. Position 3: for small children
5. Position 4: for table top extension

Make sure the bench is securely fixed and is hanging in a horizontal position.



ANCHORING

Gargantua table comes with an optional floor anchoring set: four jugged steel plates to be fixed with bolts.

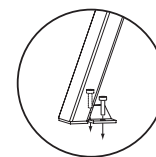

GOOD TO KNOW

1. The slight movement you feel when sitting down is the result of the space we need to hook or unhook the benches. If this would be too narrow, moving the benches would no longer be possible.
2. The Iroko wood used in every Gargantua table is FSC® certified, which ensures that the wood we buy is sourced from legal, well managed forests.

IMPORTANT

With all the benches at top level 12 chairs can be put around the table. However, the benches do not form one closed surface with the round table top. This position is meant for exceptional situations, like family reunions and parties.

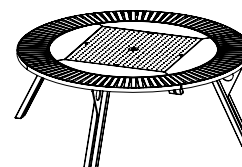

F.A.Q.

Q: Do you need to oil the wood?

A: Only if you want to maintain the original dark colour of the wood. If you don't treat it with oil, the wood will turn grey.

Q: All benches on the highest level = a table for 12 persons?

A: YES, but this position is not meant to use all the time.

MAINTENANCE

De Projectinrichter

www.deprojectinrichter.com
088 - 650 12 34