

Bekijk hier de complete [Buzzispace](#) collectie.

BuzziMilk Stool & SideTable

There's something about a milking stool that makes us feel at home - even at work. This rustic-meets-modern take on the old farmhouse favourite would even make your grandma proud.

BuzziMilk is an earnest little stool inspired by elements not usually found in a standard office space in order to create a warm and homey feeling at work. But unlike your grandma's old milk stool, the BuzziMilk has four legs for stability and a cushion seat for a softer experience.

The same wooden structure without the cushion turns into a handy little table, and creates a dynamic and friendly work corner playing with BuzziMilk stools and tables.

With your own unique combination of BuzziSpace Fabric, including our Terra, Tartan and Rough range, and a variety of wood finishes, BuzziMilk is a moveable graphic extra in your work or home space.

Like your grandma's old stool, this one's a keeper.

Design by Alain Gilles



Stool | SideTable



frame Ash (black finish)

BuzziMilk Stool & SideTable | Content

COMPOSITION

STOOL:

- Frame: plain wood
- Seating: C43170 foam → upholstery in fabric

SIDETABLE:

- Frame: plain wood
- Seating: /

USE

- 2 x 4 glides incl. : felt side for tiles and hard surfaces | plastic side: for carpet and soft surfaces

OPTIONS

STOOL:

- Frame: Oak (matt oil)
Walnut (matt oil)
Ash (matt oil)
Ash (black stained)
- Seating: BuzziFabric | BuzziRough
BuzziTerra | BuzziTartan

SIDETABLE:

- Frame: Oak (matt oil)
Walnut (matt oil)
Ash (matt oil)
Ash (black stained)
- Seating: /

BuzziMilk Stool & SideTable | Ratings

- Flammability: BuzziTartan / BuzziTerra: CRIB 5
CAL 117 PASS
- BuzziFabric: EN 1021.1/2006 | BS EN 1021.1/2006 (cigarette)
EN 1021.2/2006 | BS EN 1021.2/2006 (match)
CAL TB 117
- BuzziRough: EN 1021.1/2006 | BS EN 1021.1/2006 (cigarette)
DIN 4102 - B1
- Foam C43170: MVSS 302 MOD1
EASA CS25.853(a)
BS 5852 part2 Crib 5

BuzziMilk Stool & SideTable | Dimensions & Weight

	Size:	Weight (*):	Max. weight capacity
Stool	Ø 39 cm 47,5 cm Ø 15.35 inch 18.70 inch	±5,9 kg ±13.01 lbs	100 kg 220.46 lbs
Packaging (incl. Stool)	40,5 x 40,5 x 51 cm 15.94 x 15.94 x 20.08"	±7,1 kg ±15.65 lbs	
SideTable	Ø 39 cm 39,5 cm Ø 15.35 inch 15.55 inch	±4,1 kg ±9.04 lbs	100 kg 220.46 lbs
Packaging (incl. SideTable)	40,5 x 40,5 x 51 cm 15.94 x 15.94 x 20.08"	±5,4 kg ±11.24 lbs	

Stool

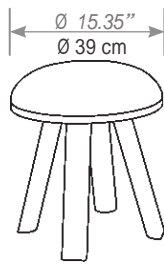

SideTable

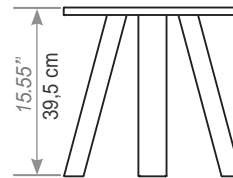
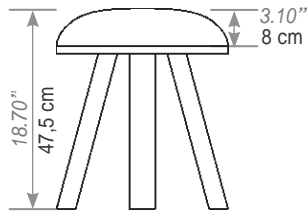

(*) As BuzziMilk comes in 3 different solid wood types (Ash, Oak, Walnut) and as wood is a very natural material, there can be variants up to 15% in the weights quoted in our PSS product specification sheets.

BuzziMilk Bench & Table

Design by Alain Gilles



BuzziMilk Bench & Table | Content

COMPOSITION

BENCH:

- Frame: plain wood
- Seating: C43170 foam → upholstery in fabric

TABLE:

- Frame: plain wood
- Seating: /

USE

- 2 x 4 glides incl. : felt side for tiles and hard surfaces | plastic side: for carpet and soft surfaces

OPTIONS

BENCH:

- Frame: Oak (matt oil)
Walnut (matt oil)
Ash (matt oil)
Ash (black stained)
- Seating: BuzziFabric | BuzziRough
BuzziTerra | BuzziTartan

TABLE:

- Frame: Oak (matt oil)
Walnut (matt oil)
Ash (matt oil)
Ash (black stained)
- Seating: /

BuzziMilk Bench & Table | Ratings

- Flammability: BuzziTartan / BuzziTerra: CRIB 5
CAL 117 PASS
- BuzziFabric: EN 1021.1/2006 | BS EN 1021.1/2006 (cigarette)
EN 1021.2/2006 | BS EN 1021.2/2006 (match)
CAL TB 117
- BuzziRough: EN 1021.1/2006 | BS EN 1021.1/2006 (cigarette)
DIN 4102 - B1
- Foam C43170: MVSS 302 MOD1
EASA CS25.853(a)
BS 5852 part2 Crib 5

BuzziMilk Bench & Table | Dimensions & Weight

	Size:	Weight (*):	Max. weight capacity
Bench	39 x 119 x 50 cm <i>15.35 x 46.85 x 19.70 inch</i>	$\pm 14,6$ kg ± 32.19 lbs	150 kg 330.69 lbs
Packaging (incl. Bench)	40,5 x 121 x 54 cm <i>15.94 x 47.64 x 21.26"</i>	$\pm 17,3$ kg ± 38.14 lbs	
Table	39 x 119 x 39,5 cm <i>15.35 x 46.85 x 15.55 inch</i>	$\pm 8,1$ kg ± 17.86 lbs	50 kg 110.23 lbs
Packaging (incl. Table)	40,5 x 121 x 54 cm <i>15.94 x 47.64 x 21.26"</i>	$\pm 13,5$ kg ± 29.76 lbs	

Bench

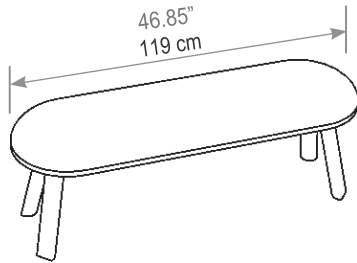

Table

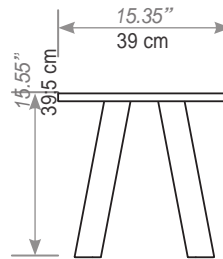
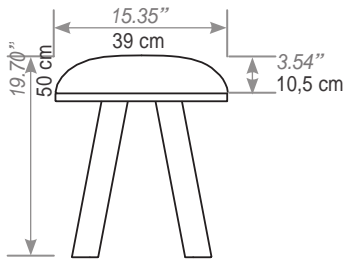
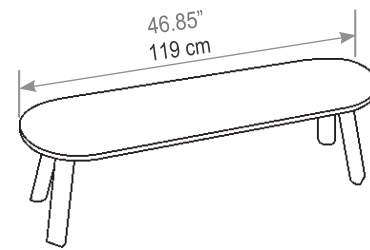

(*) As BuzziMilk comes in 3 different solid wood types (Ash, Oak, Walnut) and as wood is a very natural material, there can be variants up to 15% in the weights quoted in our PSS product specification sheets.

BuzziMilk BarStool High & Low

Design by Alain Gilles



BuzziMilk BarStool High & Low | Content

COMPOSITION

- Frame: plain wood
- Seating: C43170 foam → upholstery in fabric
- Footrest: metal powdercoated RAL 9005 black matte

USE

- 2 x 4 glides incl. : felt side for tiles and hard surfaces | plastic side: for carpet and soft surfaces

OPTIONS

- Height: Low: 68 cm | 26.77"
High: 78 cm | 30.71"
- Frame: Oak (matt oil)
Walnut (matt oil)
Ash (matt oil)
Ash (black stained)
- Seating: BuzziFabric | BuzziRough
BuzziTerra | BuzziTartan

BuzziMilk BarStool High & Low | Ratings

- | | | |
|-----------------|---------------------------|--|
| • Flammability: | BuzziTartan / BuzziTerra: | CRIB 5
CAL 117 PASS |
| | BuzziFabric: | EN 1021.1/2006 BS EN 1021.1/2006 (cigarette)
EN 1021.2/2006 BS EN 1021.2/2006 (match)
CAL TB 117 |
| | BuzziRough: | EN 1021.1/2006 BS EN 1021.1/2006 (cigarette)
DIN 4102 - B1 |
| | Foam C43170: | MVSS 302 MOD1
EASA CS25.853(a)
BS 5852 part2 Crib 5 |

BuzziMilk BarStool High & Low | Dimensions & Weight

	Size:	Weight (*):
Low	Ø 39 cm 67,5 cm Ø 15.35 inch 26.57 inch	±7,2 kg ±15.87 lbs
Packaging (incl. BarStool Low)	40,5 x 40,5 x 81 cm 15.94 x 15.94 x 31.89"	±8,8 kg ±19.40 lbs
High	Ø 39 cm 77,5 cm Ø 15.35 inch 30.51 inch	±7,8 kg ±17.20 lbs
Packaging (incl. BarStool High)	40,5 x 40,5 x 81 cm 15.94 x 15.94 x 31.89"	±9,6 kg ±21.16 lbs

High

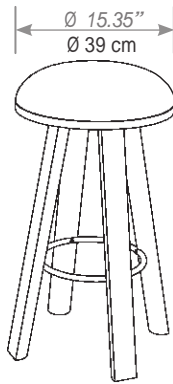

Low

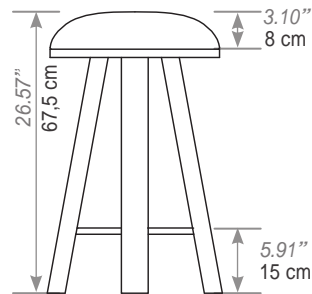
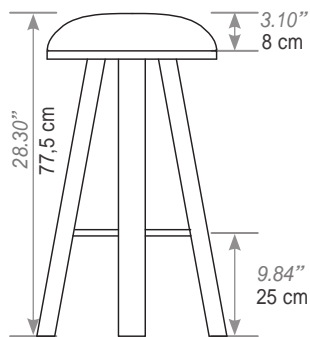
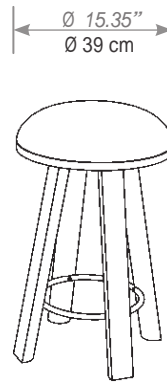

(*) As BuzziMilk comes in 3 different solid wood types (Ash, Oak, Walnut) and as wood is a very natural material, there can be variants up to 15% in the weights quoted in our PSS product specification sheets.

BuzziMilk Tile

Design by Buzzispace Design Team



BuzziMilk Tile | Content

COMPOSITION

- Backplate: 12 mm | 0.47" MDF
- Tile: C43170 foam → upholstery in fabric (random pattern)

OPTIONS

BuzziFabric | BuzziRough | BuzziTerra | BuzziTartan

BuzziMilk Tile | Ratings

• Flammability:	BuzziTartan / BuzziTerra:	CRIB 5 CAL 117 PASS
	BuzziFabric:	EN 1021.1/2006 BS EN 1021.1/2006 (cigarette) EN 1021.2/2006 BS EN 1021.2/2006 (match) CAL TB 117
	BuzziRough:	EN 1021.1/2006 BS EN 1021.1/2006 (cigarette) DIN 4102 - B1
	Foam C43170:	MVSS 302 MOD1 EASA CS25.853(a) BS 5852 part2 Crib 5



BuzziMilk Tile | Dimensions & Weight

Size:

Ø 39 cm | 7,5 cm
Ø 15.35 inch | 2.95 inch

Weight:

±1,30 kg
±2.87 lbs

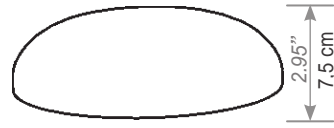
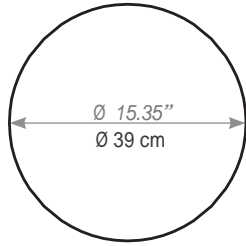

backside:

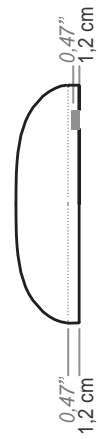
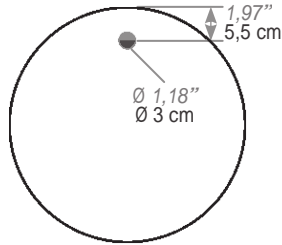

pattern in upholstery: random

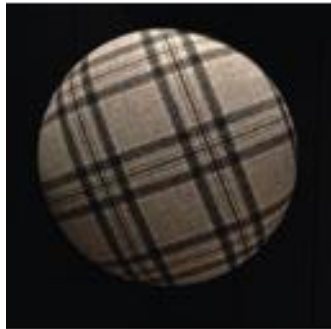

fixing system



De Projectinrichter

www.deprojectinrichter.com
088 - 650 12 34

